

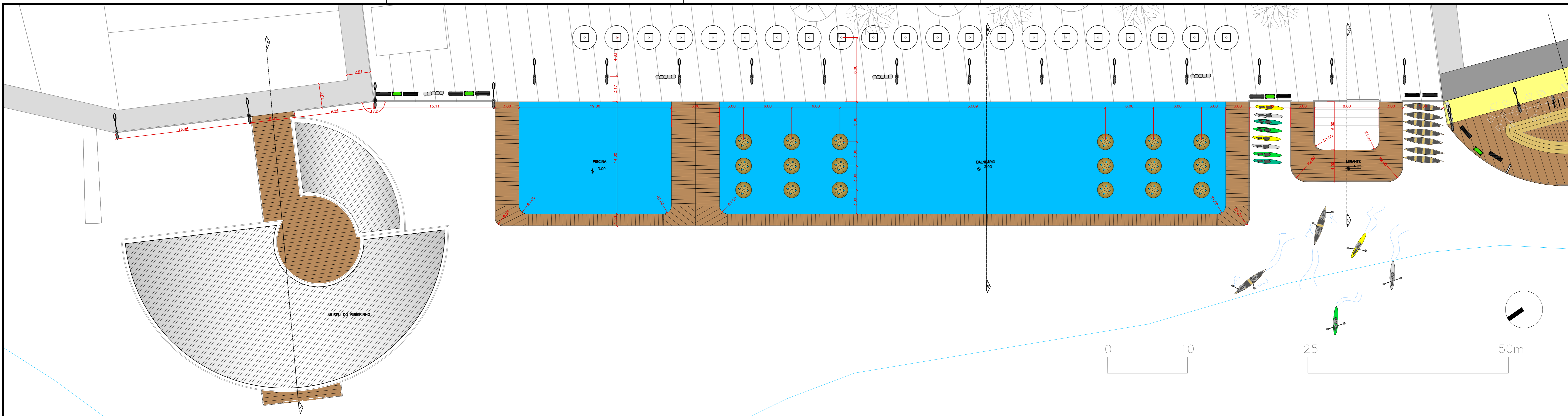

IMPLANTAÇÃO GERAL
esc 1:700

LEGENDA		
VEGETAÇÃO		
	NOME COMUM	NOME CIENTÍFICO
HERBÁCEA		
	VEGETAÇÃO ARBUSTIVA	-
	TABOCA (BAMBU)	<i>Guadua weberbaueri</i>
	ANINGA	<i>Montrichardia linifera</i>
ÁRVORES		
	IPÊ AMARELO	<i>Tabebuia serratifolia</i>
PALMEIRAS		
	BURITI	<i>Mauritia flexuosa</i>
	AÇAÍ	<i>Euterpe oleracea</i>
ÁRVORES EXISTENTES		
	FICUS	<i>Ficus benjamina</i>
	CASTANHOLEIRA	<i>Terminalia catappa</i>
	MANGUEIRA	<i>Mangifera indica</i>
	JAMBEIRO	<i>Eugenia malaccensis</i>
PISOS		
	DECK EM MADEIRA DE LEI	
	DECK EM MADEIRA DE LEI	
	PISO EM CONCRETO ARMADO	
	PISO EM CONCRETO ARMADO (PASSEIO PEDESTRES)	
	PISO INTERTRAVADO DE CONCRETO DRENANTE (COR TERRACOTA)	
	PISO EM ARMADO EXISTENTE (RUAS)	
	DECK EM MADEIRA EXISTENTE	
MOBILIÁRIO URBANO		
	PERGOLADO MATAPÍ	
	PERGOLADO SALSA BRAVA	
	SOMBRITE	
	ESCULTURA	
	QUIOSQUES DE PIAÇA	



PLANTA BAIXA - EIXO 1 A 2
esc: 1:200

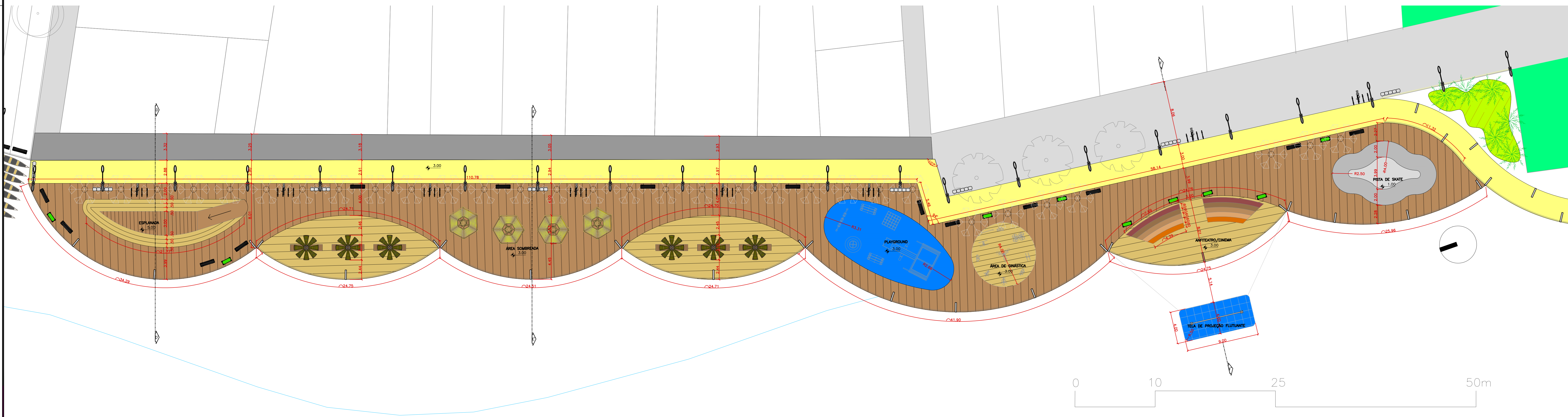

PLANTA BAIXA - EIXO 2 A 3
esc: 1:200

LEGENDA

VEGETAÇÃO		
	NOME COMUM	NOME CIENTÍFICO
HERBÁCEA		
	VEGETAÇÃO ARBUSTIVA	-
	TABOCA (BAMBU)	<i>Guadua Weberbaueri</i>
	ANINGA	<i>Montrichardia linifera</i>
ÁRVORES		
	IPÊ AMARELO	<i>Tabebuia serratifolia</i>
PALMEIRAS		
	BURITI	<i>Mauritia flexuosa</i>
	AÇAÍ	<i>Euterpe oleracea</i>
ÁRVORES EXISTENTES		
	FICUS	<i>Ficus benjamina</i>
	CASTANHOLEIRA	<i>Terminalia catappa</i>
	MANGUEIRA	<i>Mangifera indica</i>
	JAMBEIRO	<i>Eugenia malaccensis</i>
PISOS		
	DECK EM MADEIRA DE LEI	
	DECK EM MADEIRA DE LEI	
	PISO EM CONCRETO ARMADO	
	PISO EM CONCRETO ARMADO (PASSEIO)	
	PISO EM CONCRETO ARMADO EXISTENTE (RUAS)	
	DECK EM MADEIRA EXISTENTE	
MOBILIÁRIO URBANO		
	PERGOLADO MATAPÍ	
	PERGOLADO SALSA BRAVA	
	SOMBRITE	
	ESCULTURA	
	QUIOSQUES DE PIAÇAVA	
	ILUMINAÇÃO ALTA (8m)	
	ILUMINAÇÃO MÉDIA (4m)	
	LIXEIRAS	
	BANCO	
	FLOREIRA	
	BICICLETÁRIO	

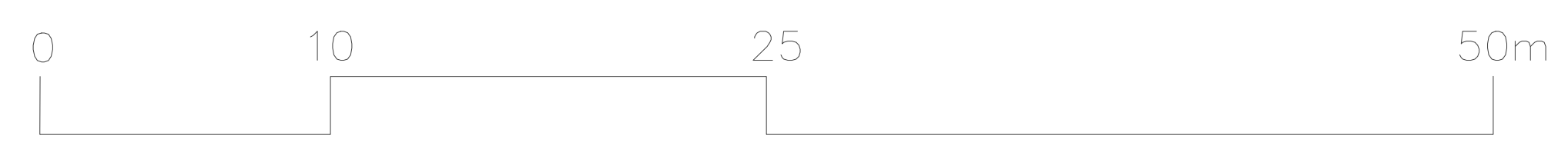
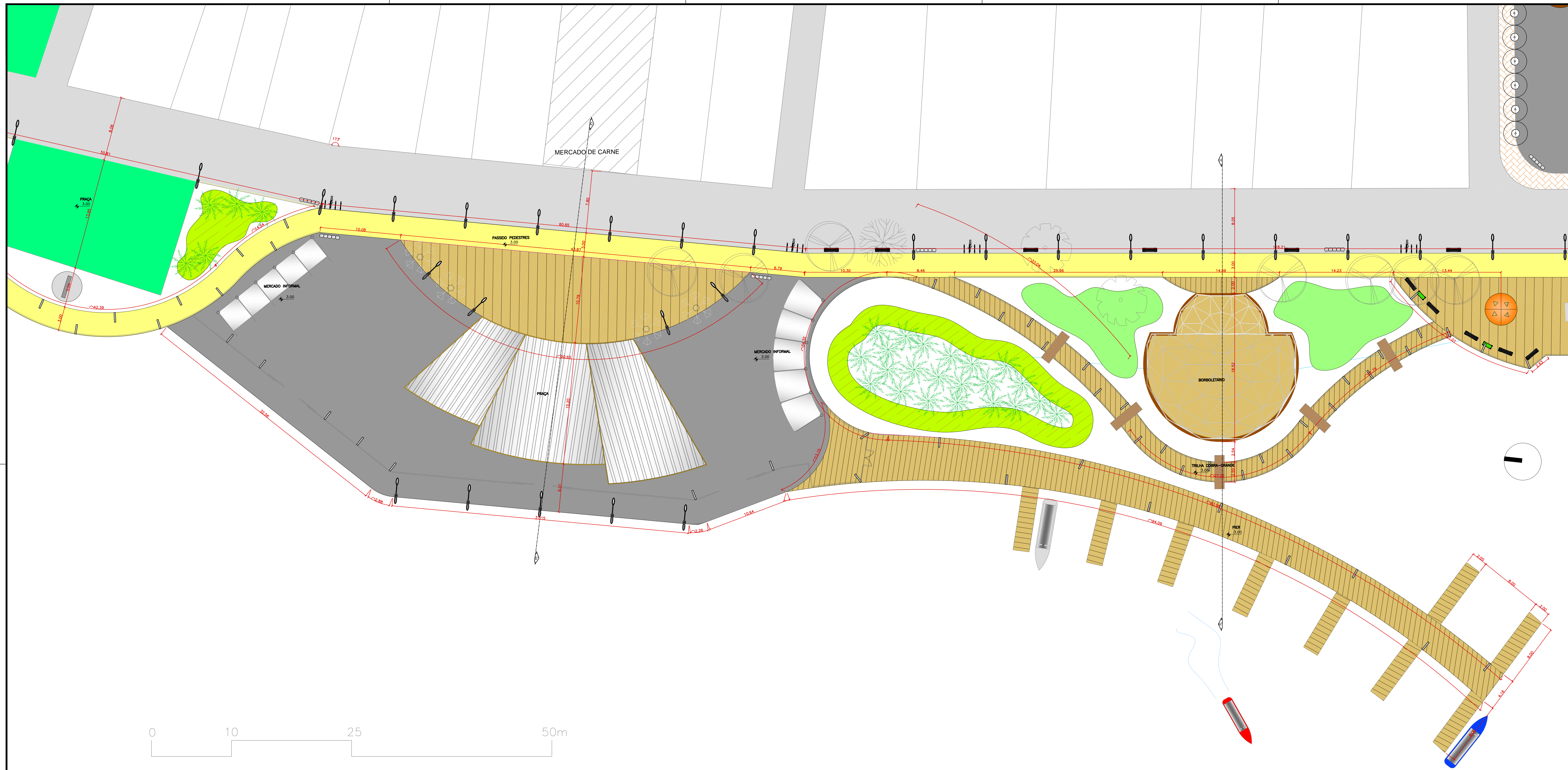

PLANTA BAIXA - EIXO 3 A 4
esc. 1:200

LEGENDA		
VEGETAÇÃO		
	NOME COMUM	NOME CIENTÍFICO
HERBÁCEA		
	VEGETAÇÃO ARBUSTIVA	-
	TABOÇA (BAMBU)	<i>Guadua Weberbaueri</i>
	ANINGA	<i>Montrichardia linifera</i>
ÁRVORES		
	IPÊ AMARELO	<i>Tabebuia serratifolia</i>
PALMEIRAS		
	BURITI	<i>Mauritia flexuosa</i>
	AÇAÍ	<i>Euterpe oleracea</i>
ÁRVORES EXISTENTES		
	FIGUS	<i>Ficus benjamina</i>
	CASTANHOLEIRA	<i>Terminalia catappa</i>
	MANGUEIRA	<i>Mangifera indica</i>
	JAMBEIRO	<i>Eugenia malaccensis</i>
PISOS		
	DECK EM MADEIRA DE LEI	
	DECK EM MADEIRA DE LEI	
	PISO EM CONCRETO ARMADO	
	PISO EM CONCRETO ARMADO (PASSEIO)	
	PISO EM CONCRETO ARMADO EXISTENTE (RUAS)	
	DECK EM MADEIRA EXISTENTE	
MOBILIÁRIO URBANO		
	PERGOLADO MATAPÍ	
	PERGOLADO SALSA BRAVA	
	SOMBRITE	
	ESCULTURA	
	QUIOSQUES DE PIAÇAVA	
	ILUMINAÇÃO ALTA (8m)	
	ILUMINAÇÃO MÉDIA (4m)	
	LIXEIRAS	
	BANCO	
	FLOREIRA	
	BICICLETÁRIO	

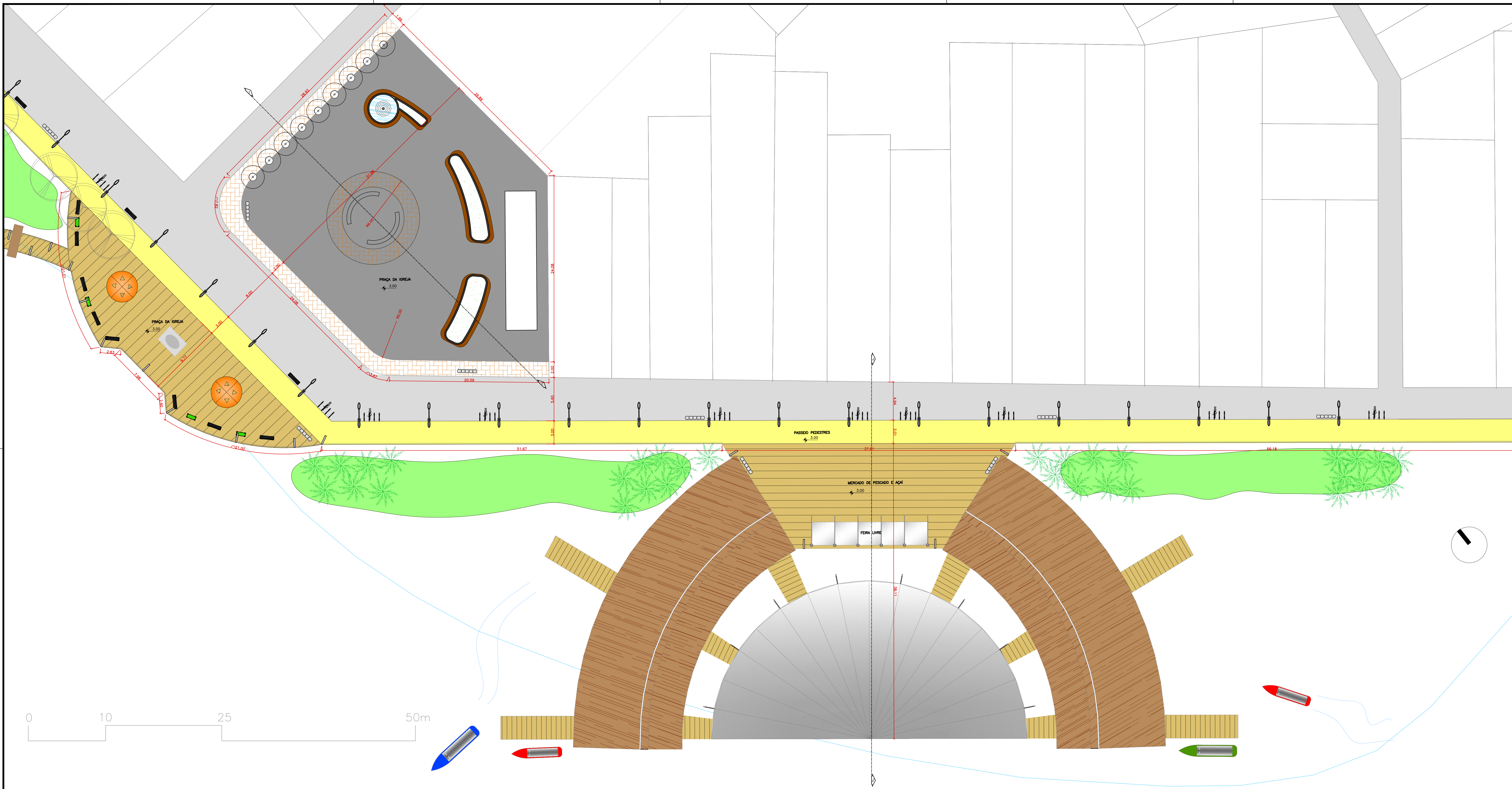

LEGENDA		
VEGETAÇÃO		
	NOME COMUM	NOME CIENTÍFICO
HERBÁCEA		
	VEGETAÇÃO ARBUSTIVA	-
	TABOCA (BAMBU)	<i>Guadua Weberbaueri</i>
	ANINGA	<i>Montrichardia linifera</i>
ÁRVORES		
	IPÊ AMARELO	<i>Tabebuia serratifolia</i>
PALMEIRAS		
	BURITI	<i>Mauritia flexuosa</i>
	AÇAÍ	<i>Euterpe oleracea</i>
ÁRVORES EXISTENTES		
	FICUS	<i>Ficus benjamina</i>
	CASTANHOLEIRA	<i>Terminalia catappa</i>
	MANGUEIRA	<i>Mangifera indica</i>
	JAMBEIRO	<i>Eugenia malaccensis</i>
PISOS		
	DECK EM MADEIRA DE LEI	
	DECK EM MADEIRA DE LEI	
	PISO EM CONCRETO ARMADO	
	PISO EM CONCRETO ARMADO (PASSEIO)	
	PISO EM CONCRETO ARMADO EXISTENTE (RUAS)	
	DECK EM MADEIRA EXISTENTE	
MOBILIÁRIO URBANO		
	PERGOLADO MATAPÍ	
	PERGOLADO SALSA BRAVA	
	SOMBRITE	
	ESCULTURA	
	QUIOSQUES DE PIAÇA	
	ILUMINAÇÃO ALTA (8m)	
	ILUMINAÇÃO MÉDIA (4m)	
	LIXEIRAS	
	BANCO	
	FLOREIRA	
	BICICLETÁRIO	

PLANTA BAIXA - EIXO 4 A 5
esc 1:200

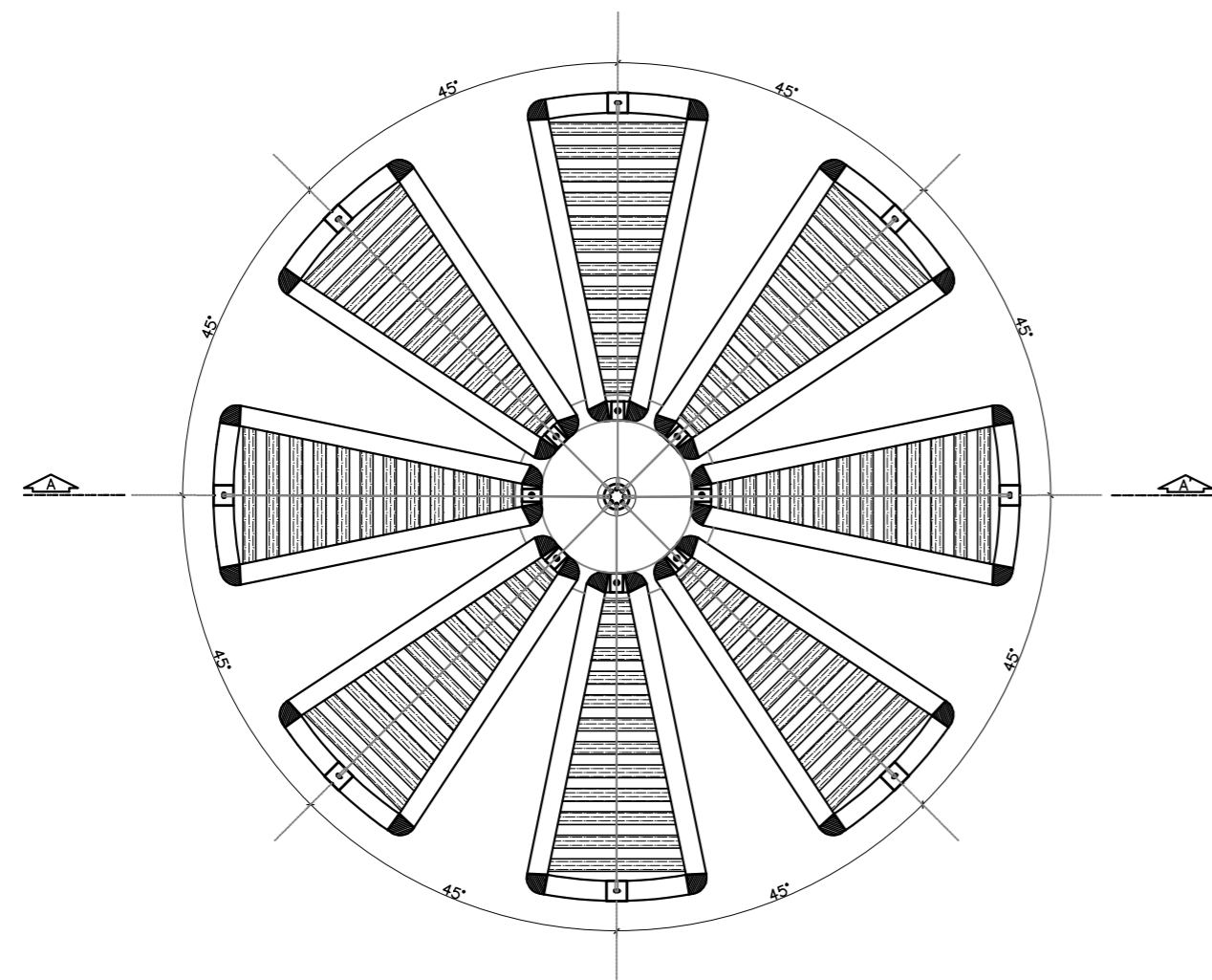

PLANTA BAIXA - PERGOLADO MATAPÍ
esc 1:20

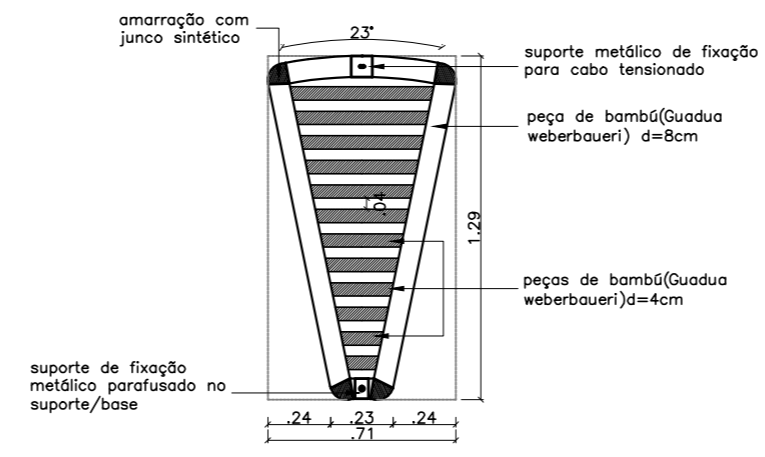

DETALHE - PÉRGOLA
esc 1:20

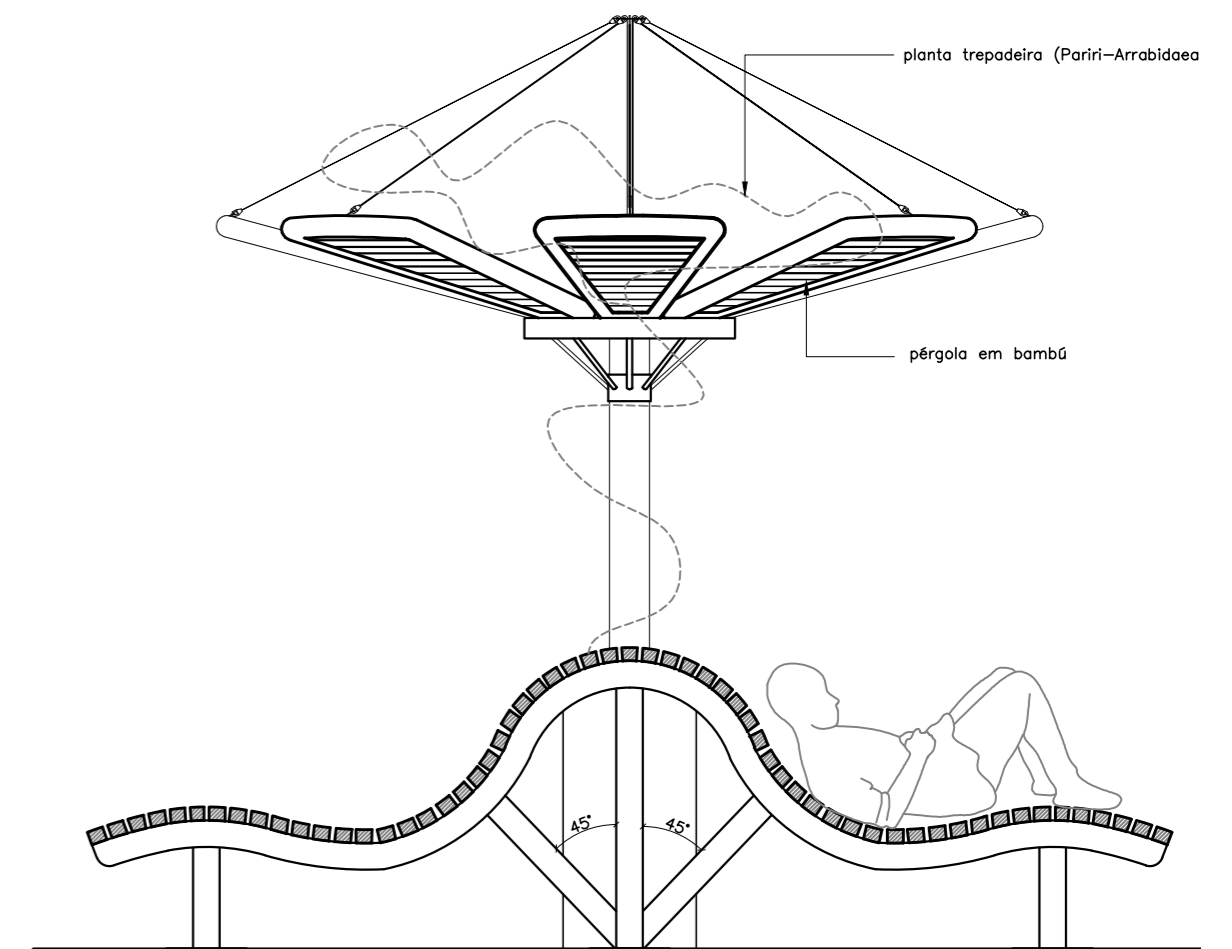

ELEVAÇÃO - PERGOLADO / ESPREGUIÇADEIRA
esc 1:20

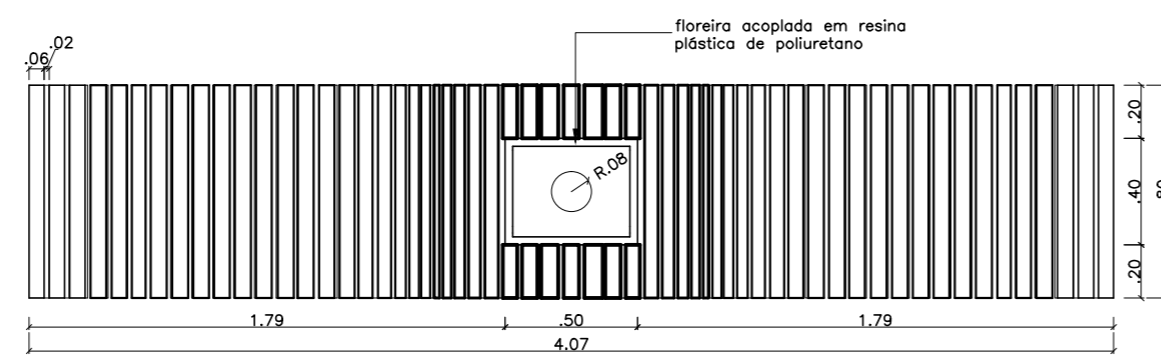

PLANTA BAIXA - ESPREGUIÇADEIRA/ FLOREIRA ACOPLADA
esc 1:20

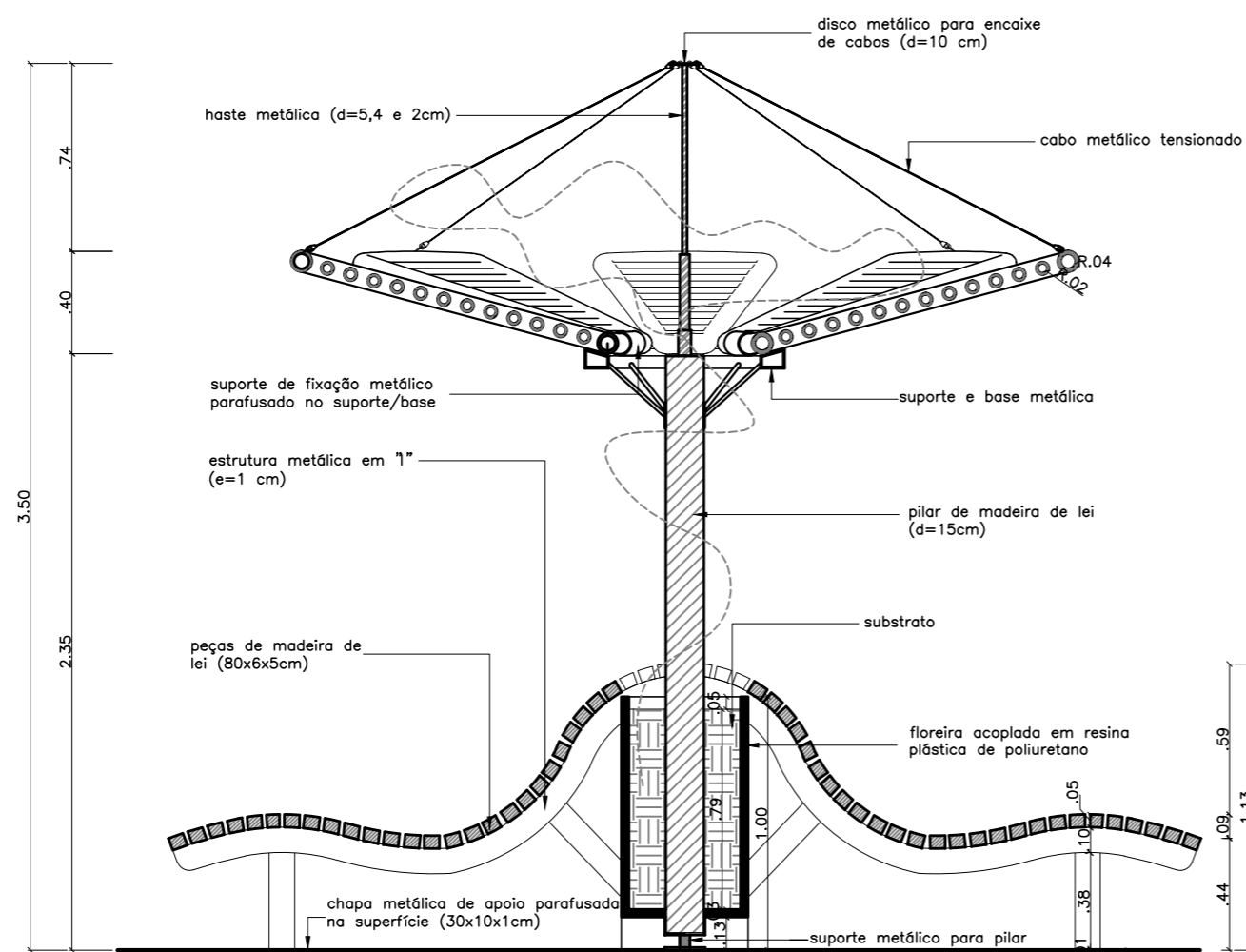

CORTE AA'- PERGOLADO / ESPREGUIÇADEIRA
esc 1:20



PERSPECTIVA - PERGOLADO / ESPREGUIÇADEIRA
sem escala

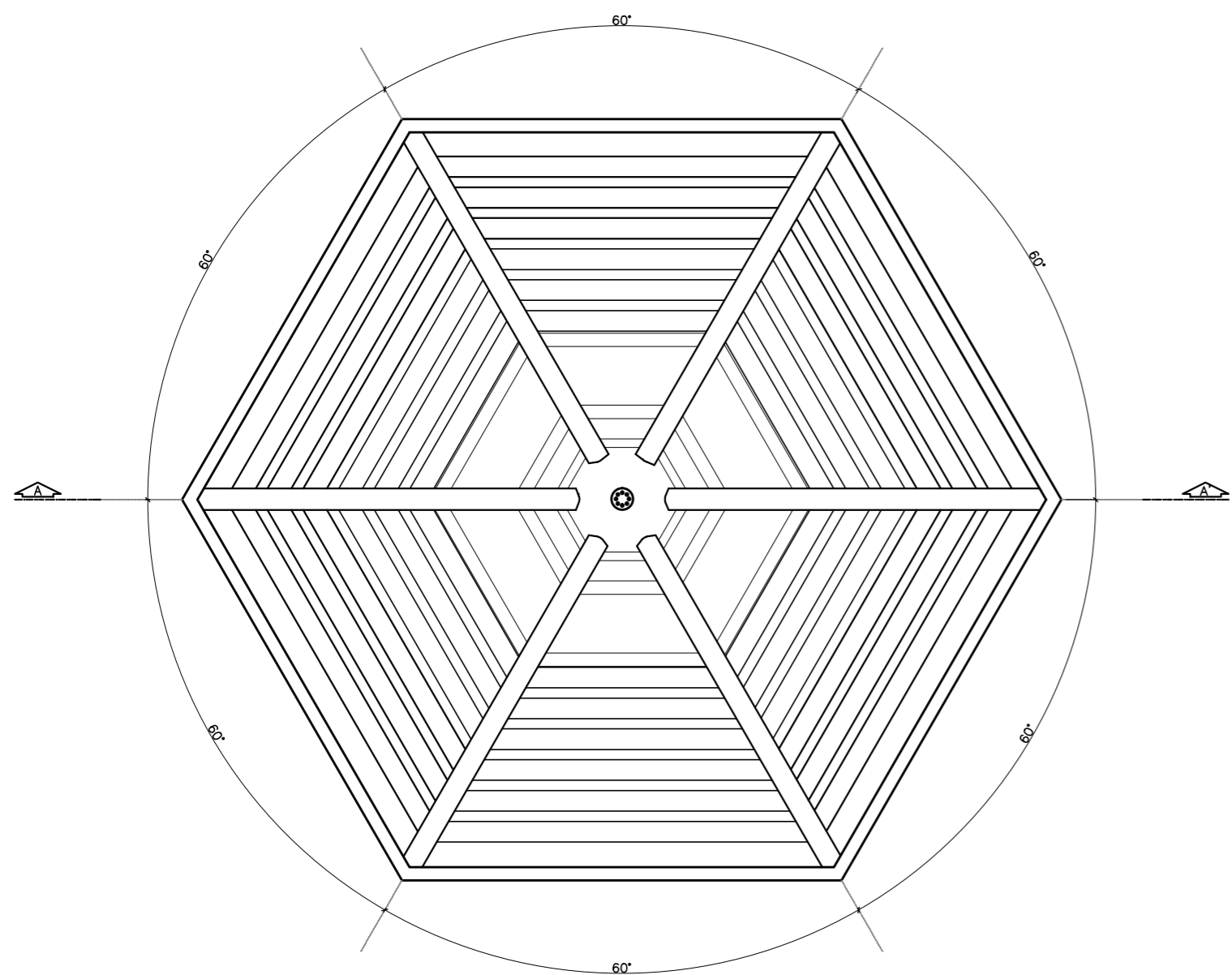

PLANTA BAIXA - PERGOLADO SALVA BRAVA
esc 1:20

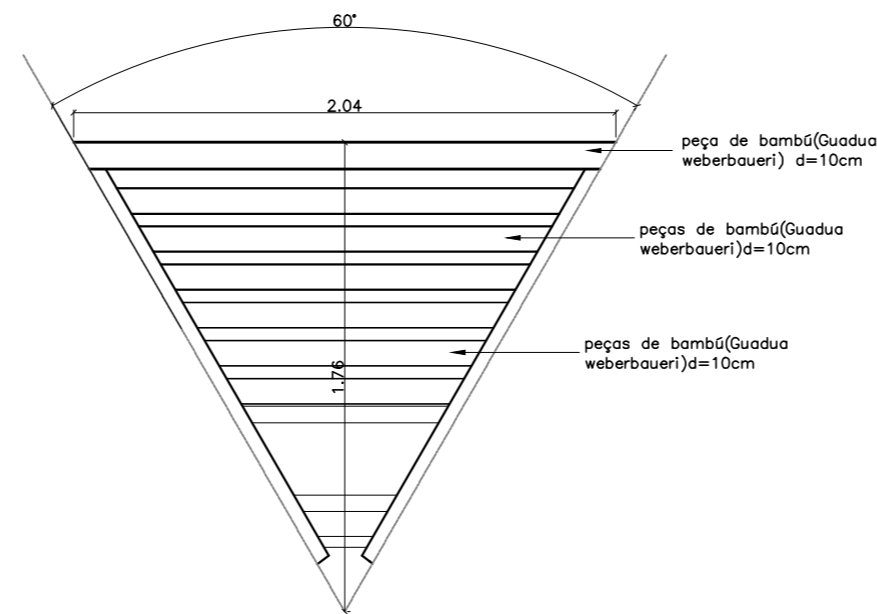

DETALHE
esc 1:20

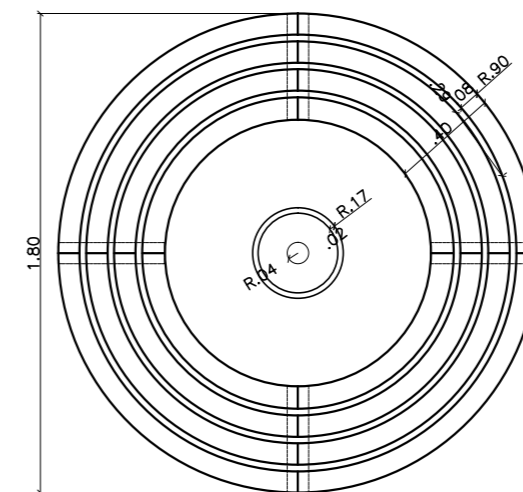

PLANTA BAIXA - BANCO/FLOREIRA CIRCULAR
esc 1:20



PERSPECTIVA - PERGOLADO/BANCO CIRCULAR
sem escala

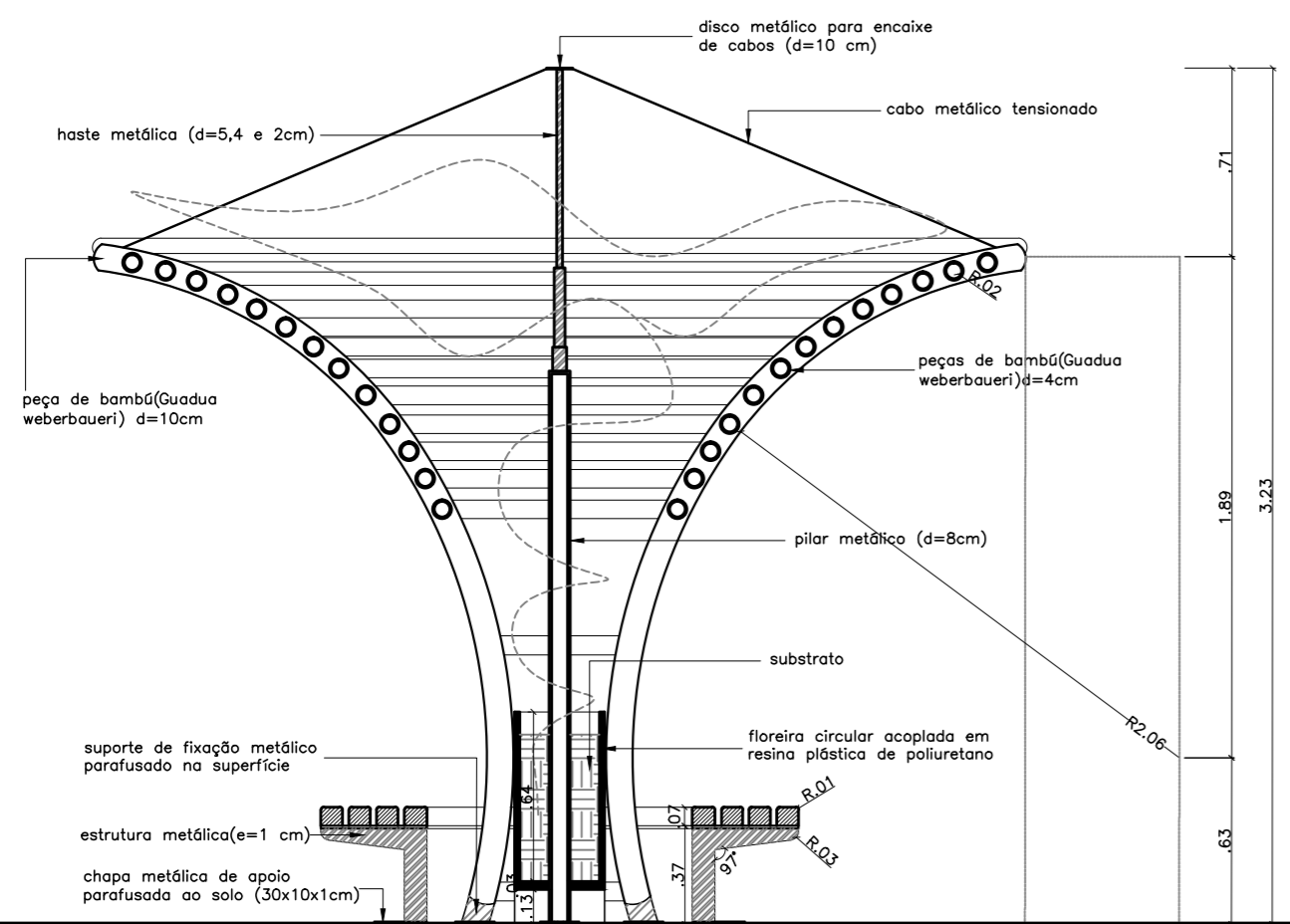

CORTE AA' - PERGOLADO/BANCO CIRCULAR
esc 1:20

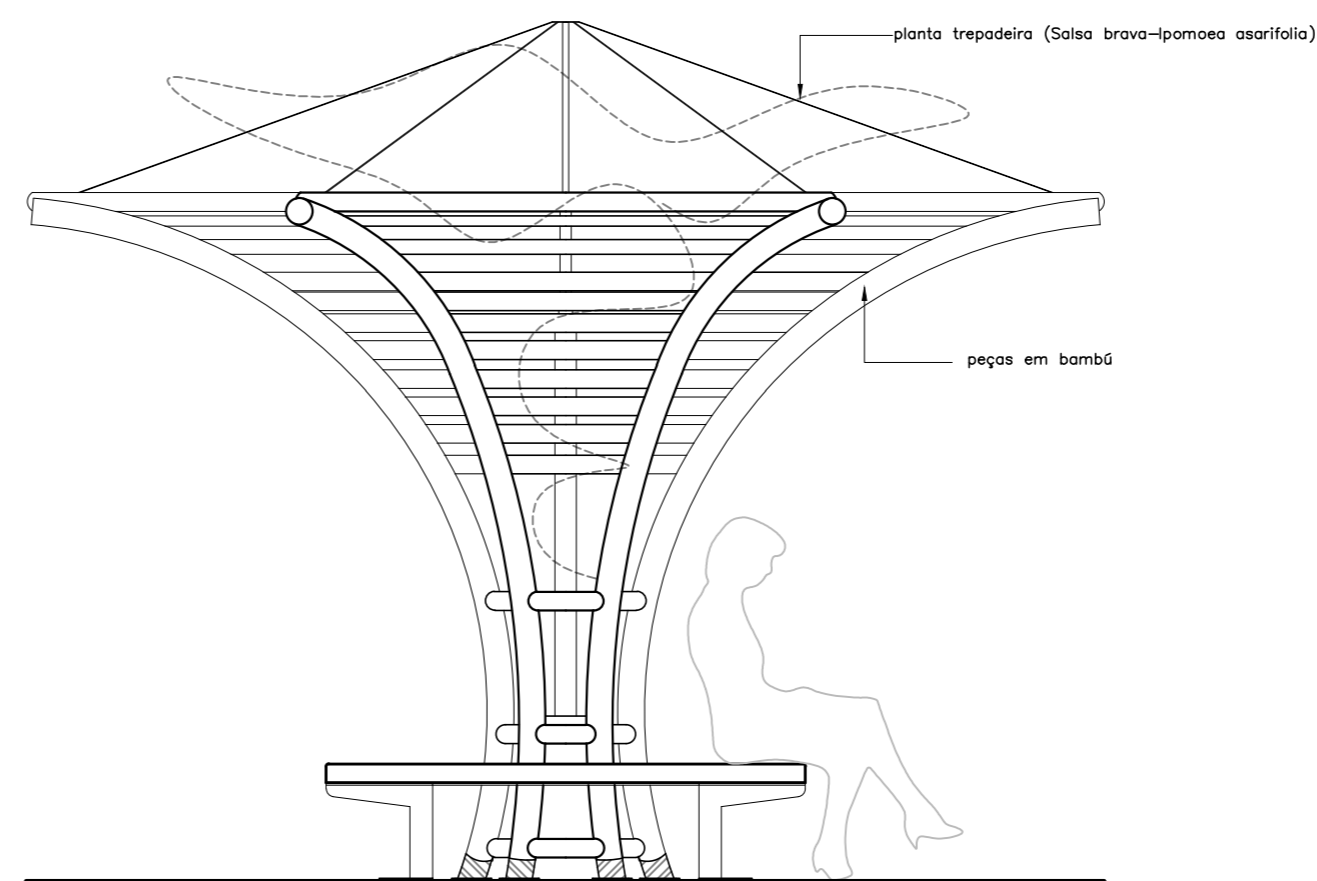

ELEVAÇÃO - PERGOLADO/BANCO CIRCULAR
esc 1:20

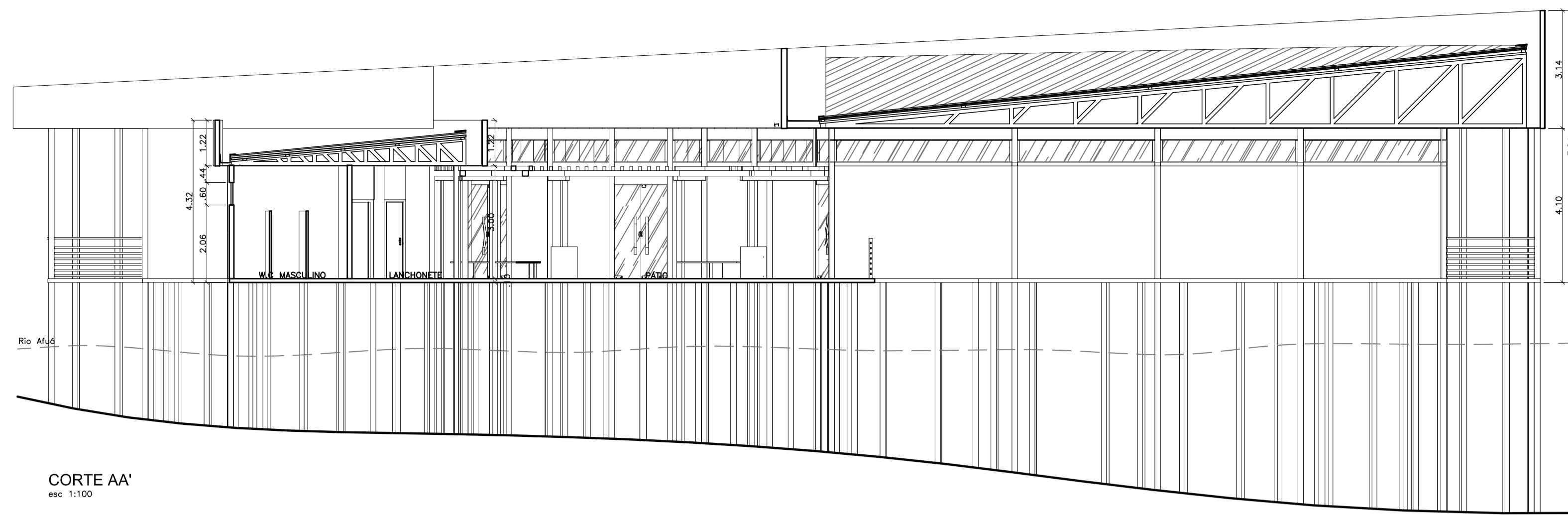

CORTE AA'
esc 1:100

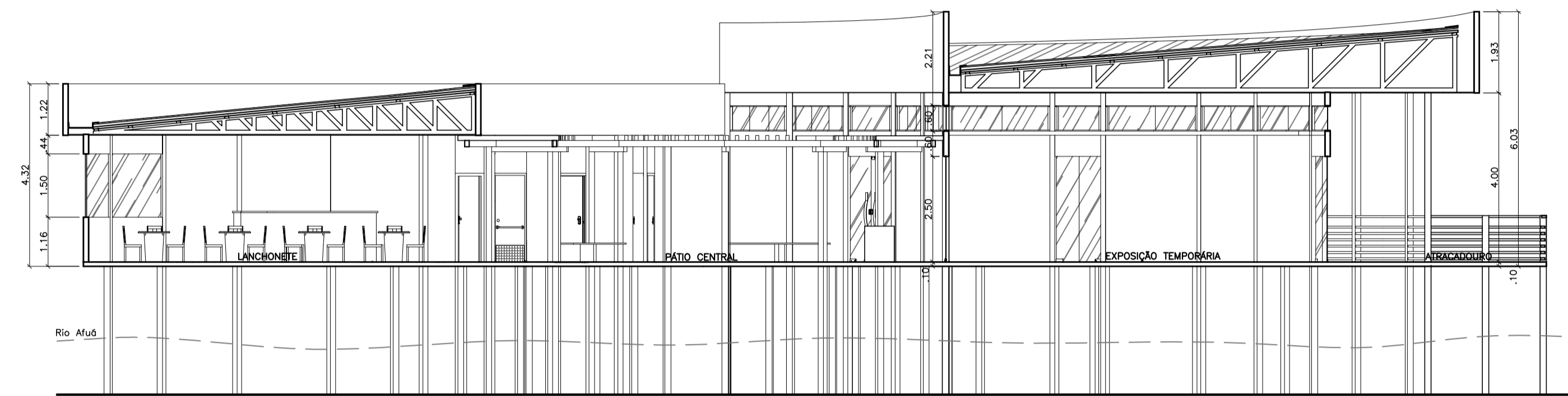

CORTE BB'
esc 1:100

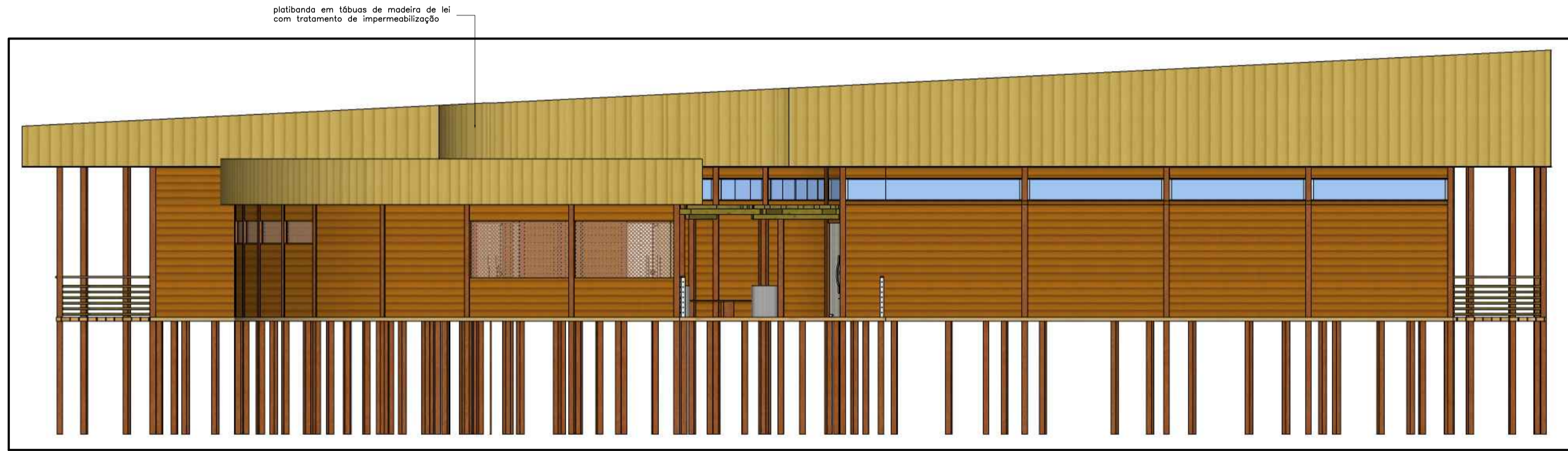

FACHADA FRONTAL
esc 1:100



FACHADA POSTERIOR
esc 1:100

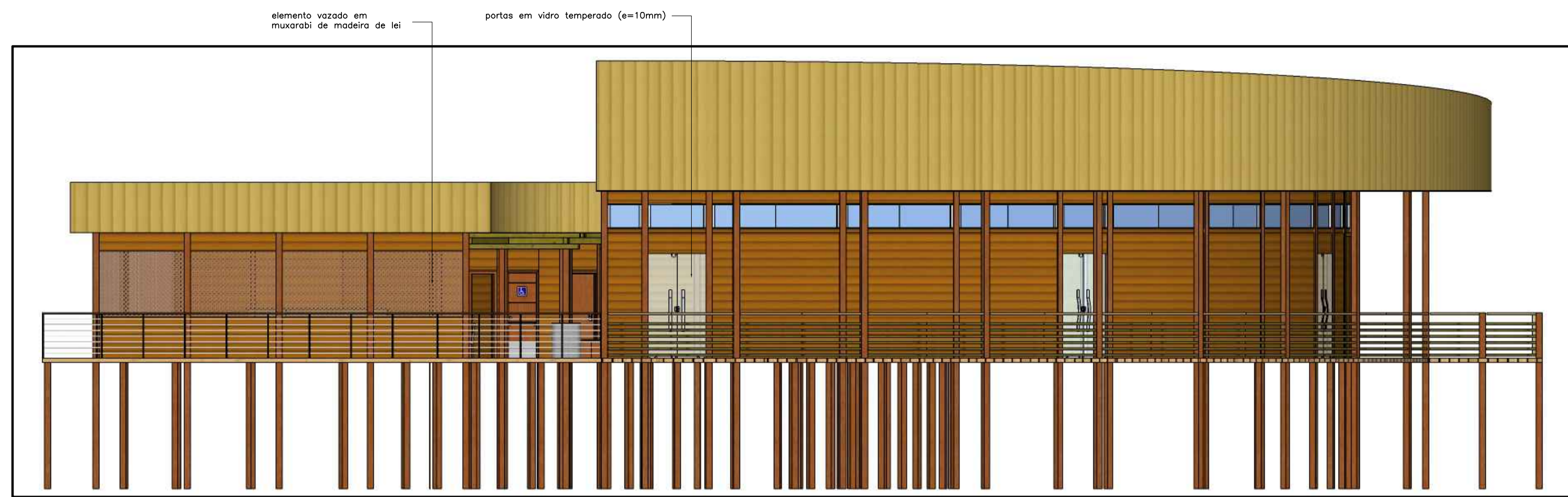

FACHADA LATERAL 1
esc. 1:100



FACHADA LATERAL 2
esc. 1:100



PERSPECTIVA 1
sem escala



PERSPECTIVA 2
sem escala

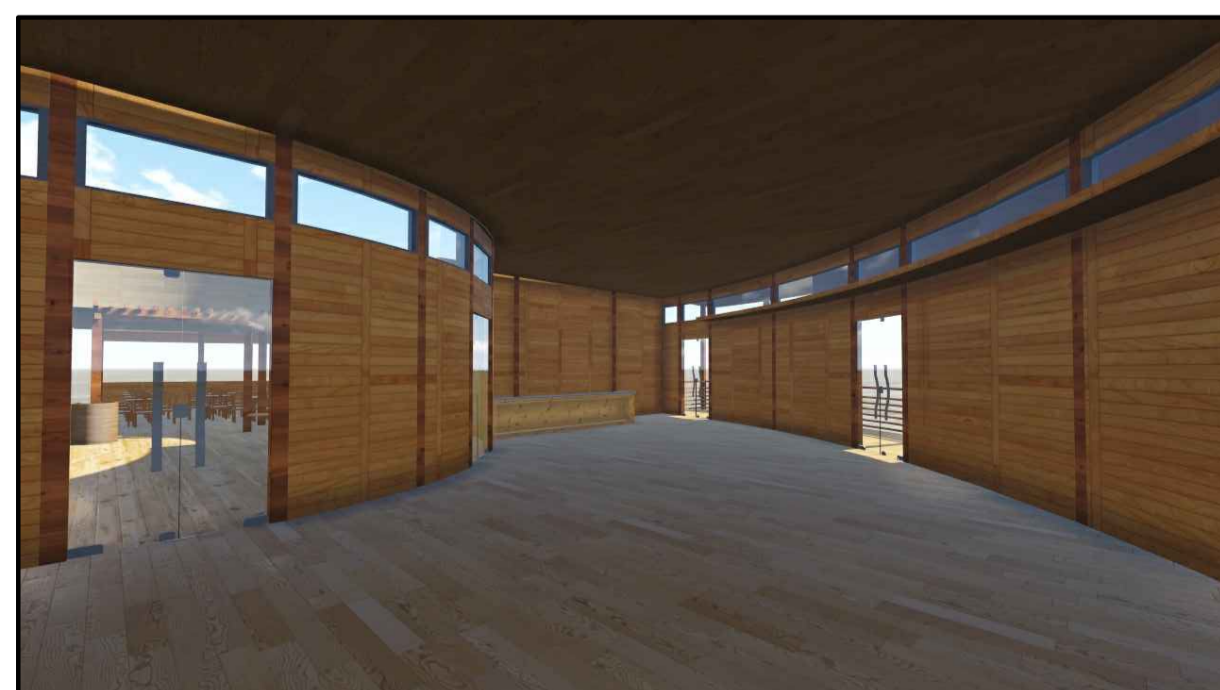

PERSPECTIVA - INTERIOR
sem escala

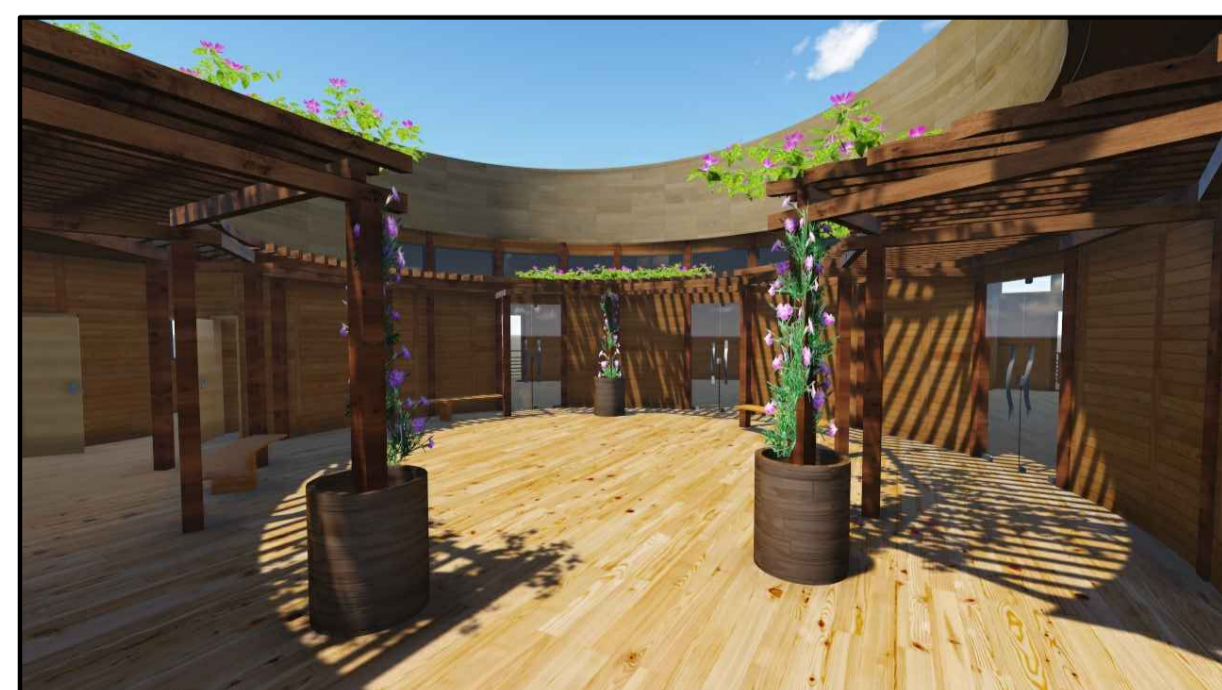

PERSPECTIVA - PÁTIO CENTRAL
sem escala



FACHADA FRONTAL
esc 1:100



FACHADA LATERAL 1
esc 1:100

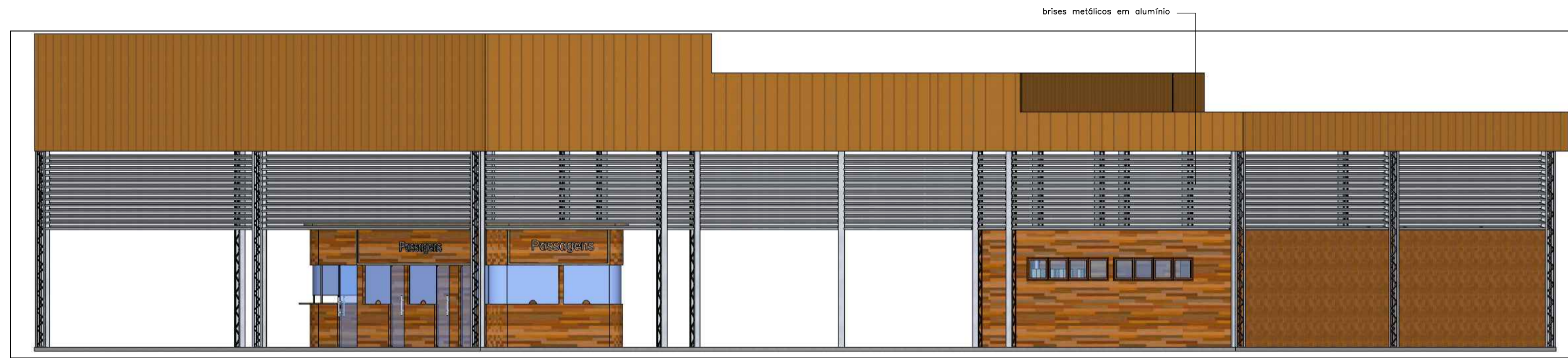

FACHADA POSTERIOR
esc 1:100



FACHADA LATERAL 2
esc 1:100



PERSPECTIVA 01
esc 1:100

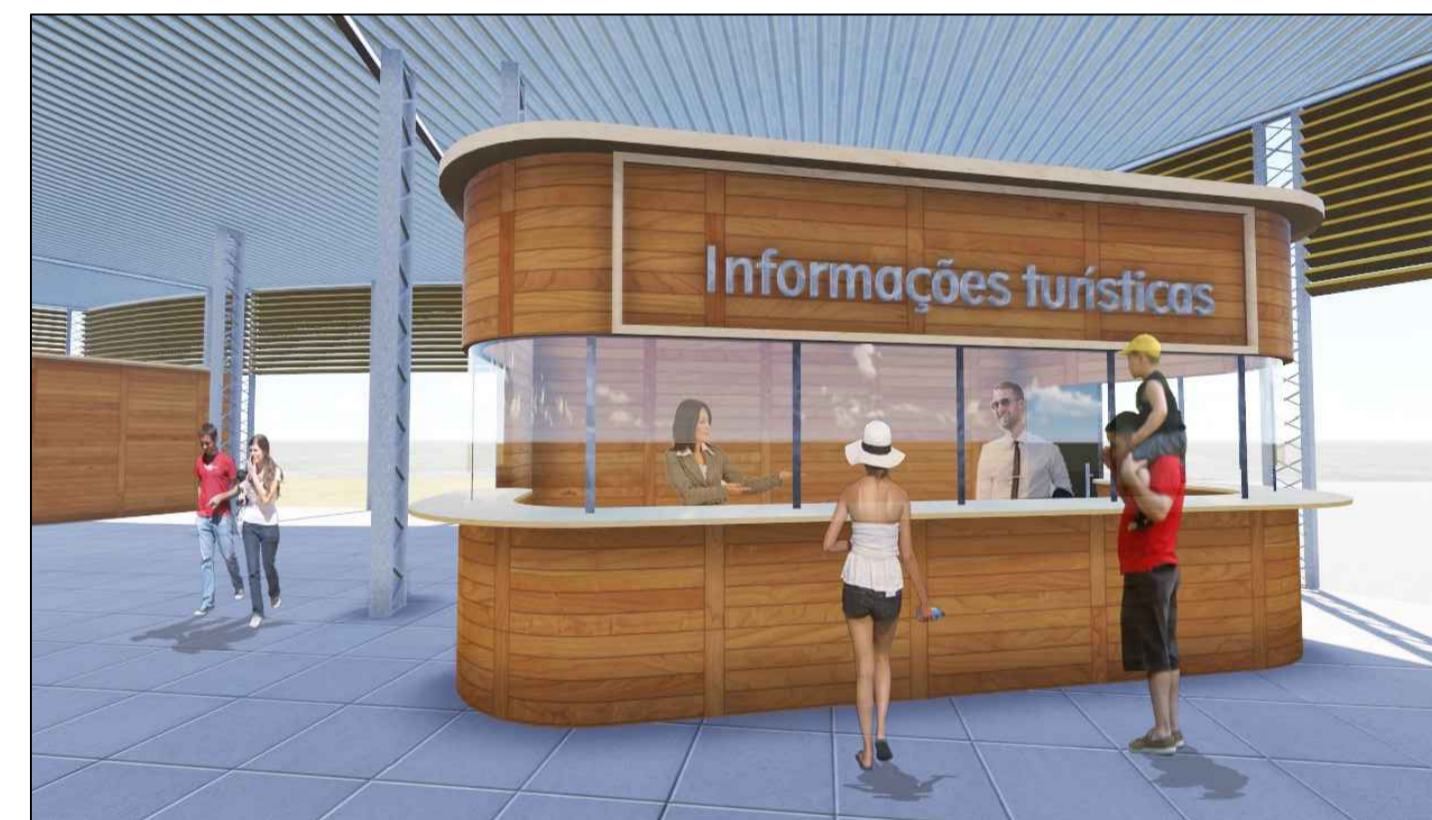

PERSPECTIVA 02
esc 1:100



PERSPECTIVA 03
esc 1:100



PERSPECTIVA 04
esc 1:100

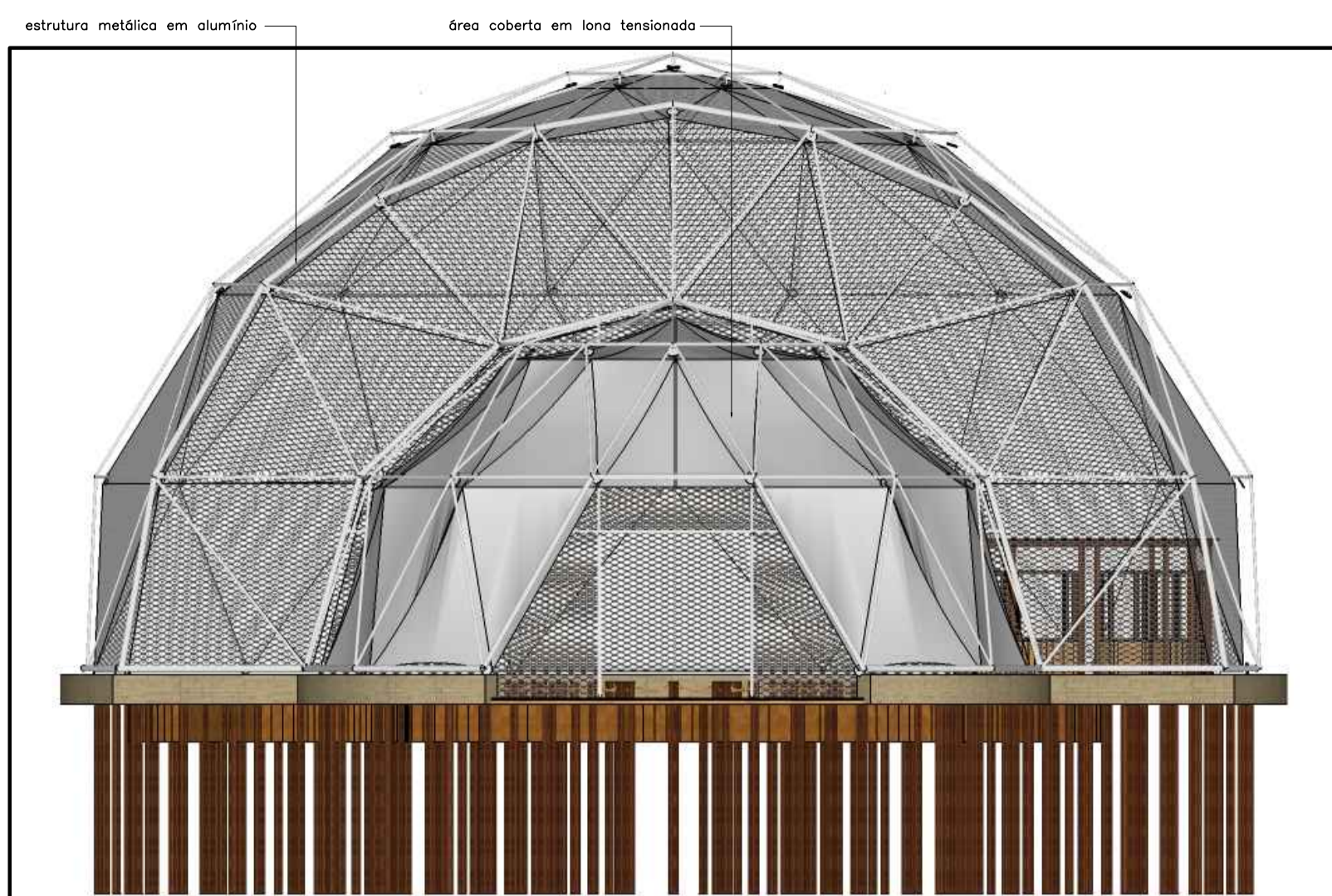

FACHADA FRONTAL
esc 1:100

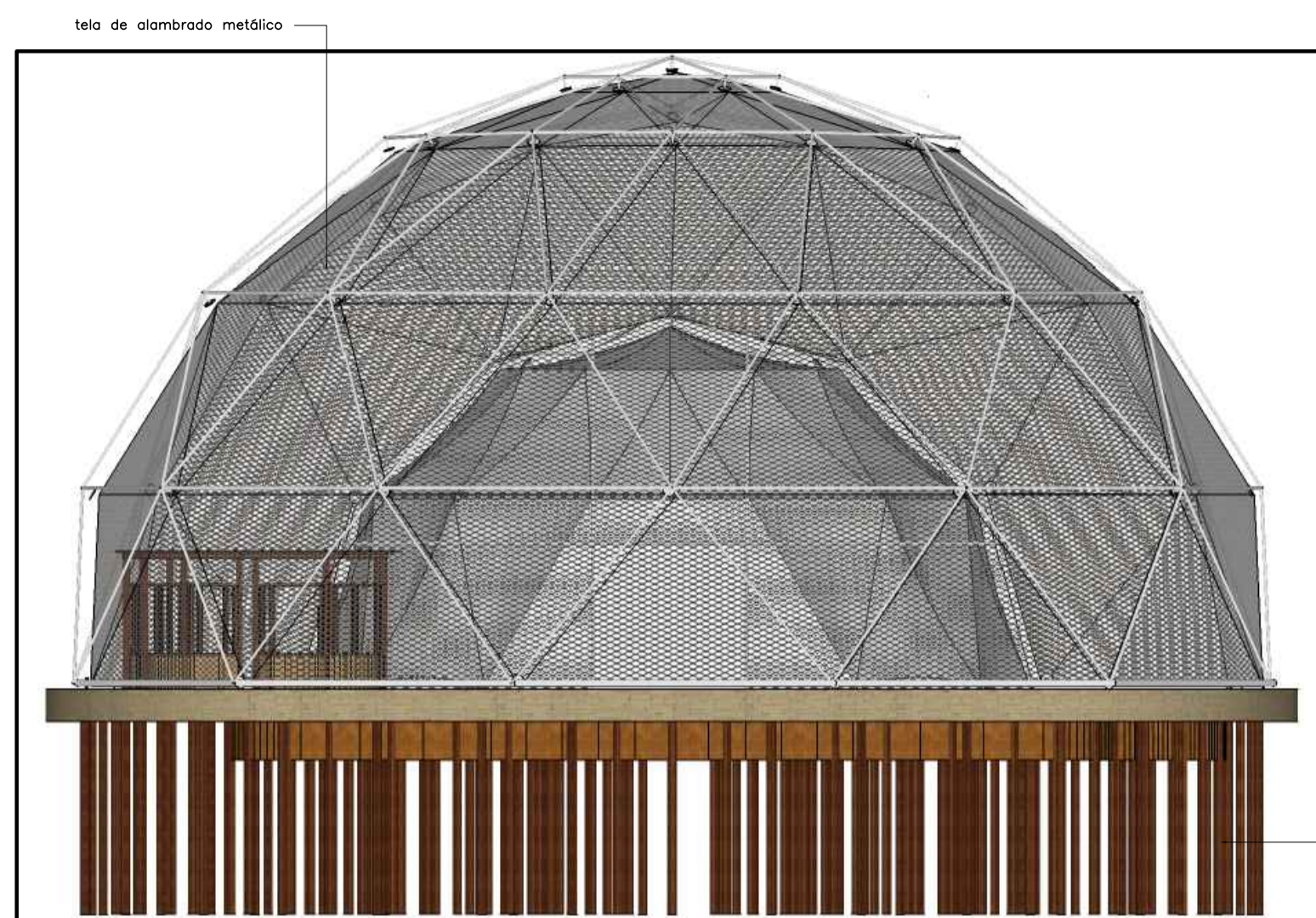

FACHADA POSTERIOR
esc 1:100

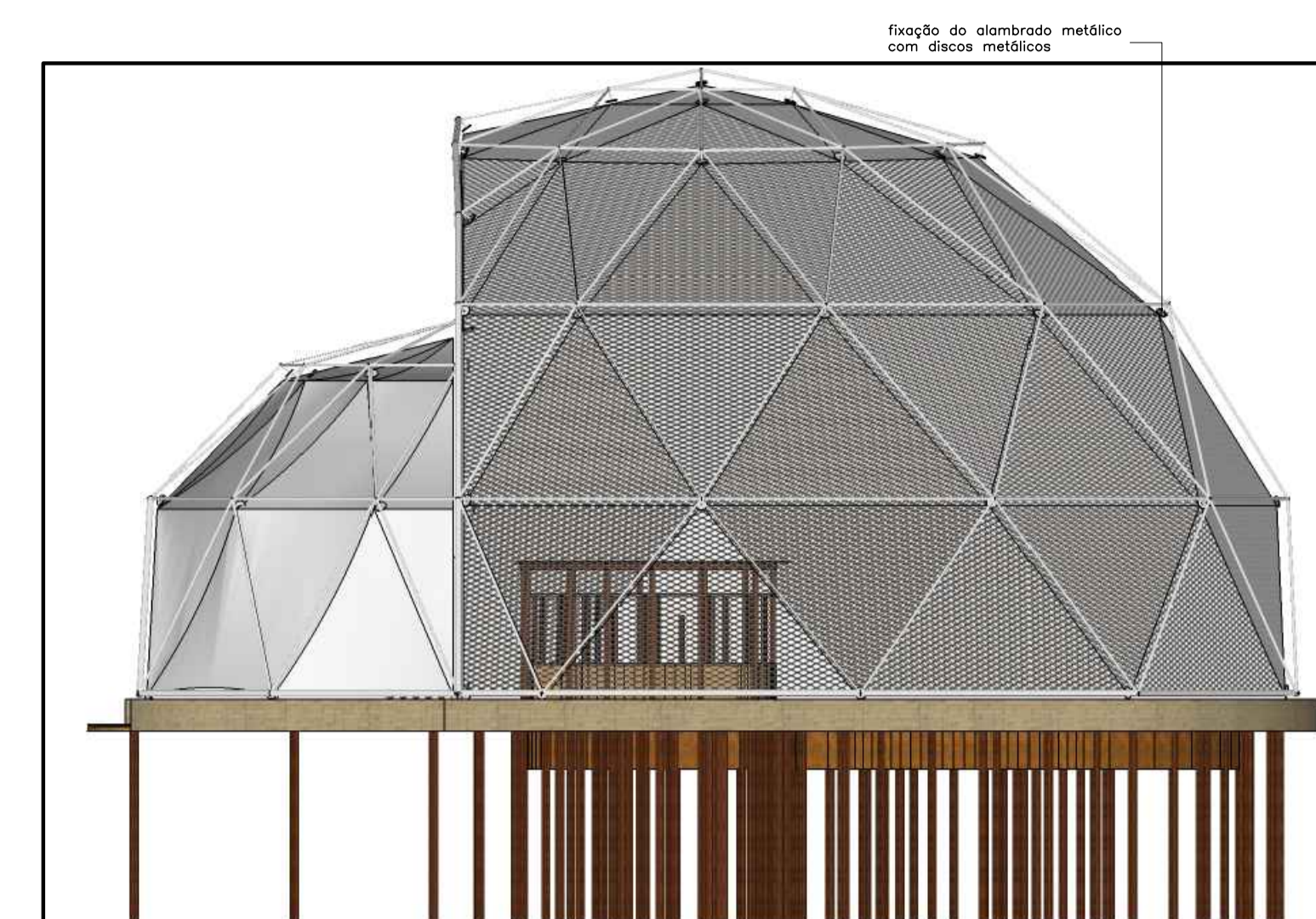

FACHADA FRONTAL
esc 1:100



PERSPECTIVA 1
sem escola

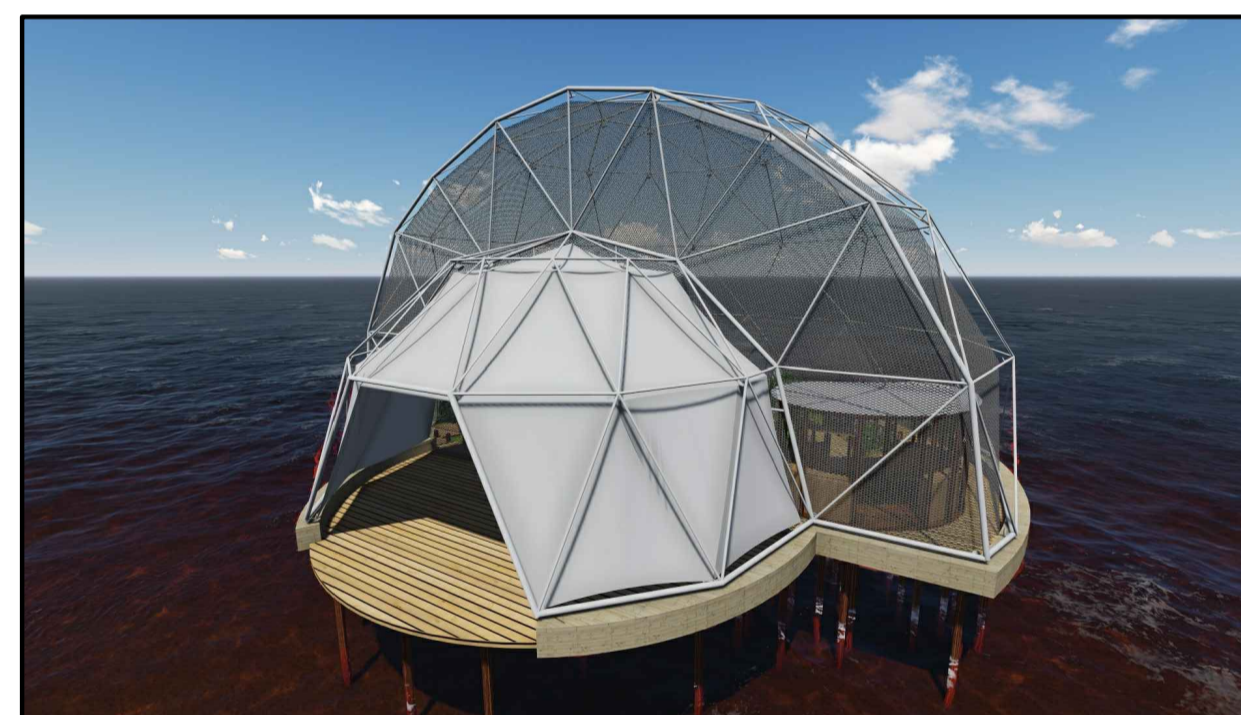

PERSPECTIVA 2
sem escola



PERSPECTIVA 3 - INTERIOR
sem escola

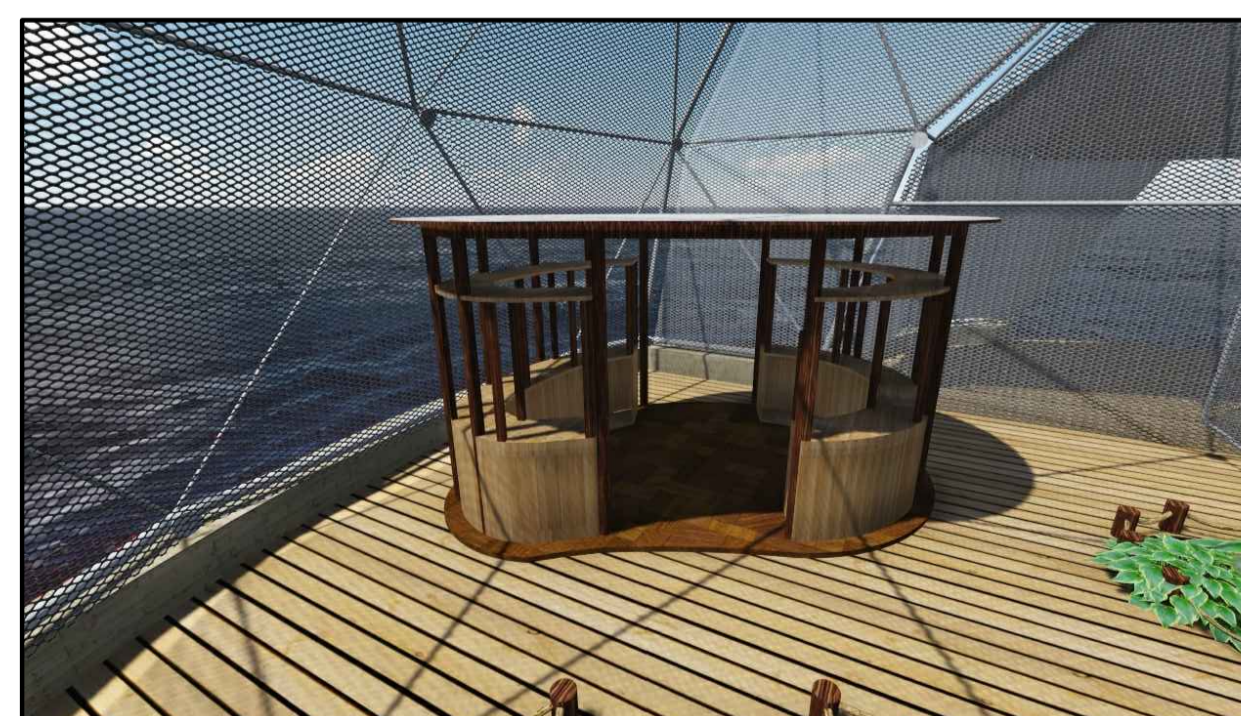

PERSPECTIVA 4 - CASA DE CRIAÇÃO
sem escola

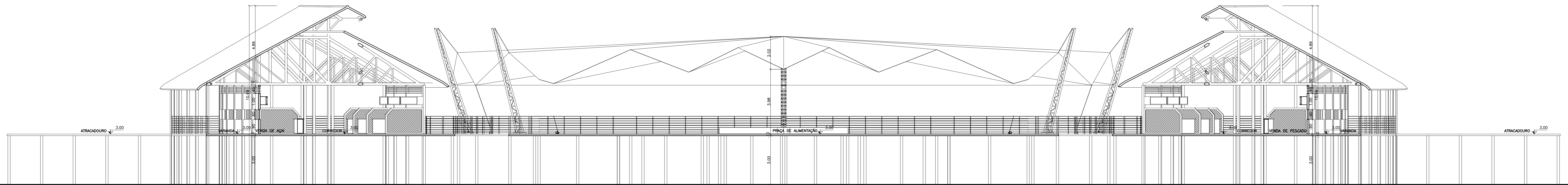

CORTE A
esc. 1:100

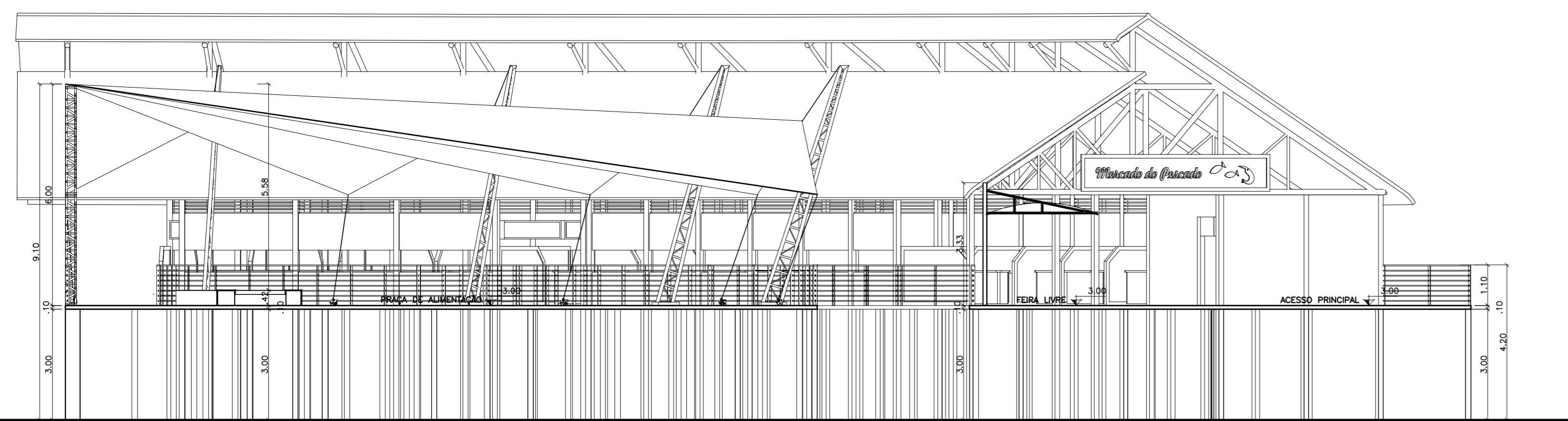

CORTE B
esc. 1:100

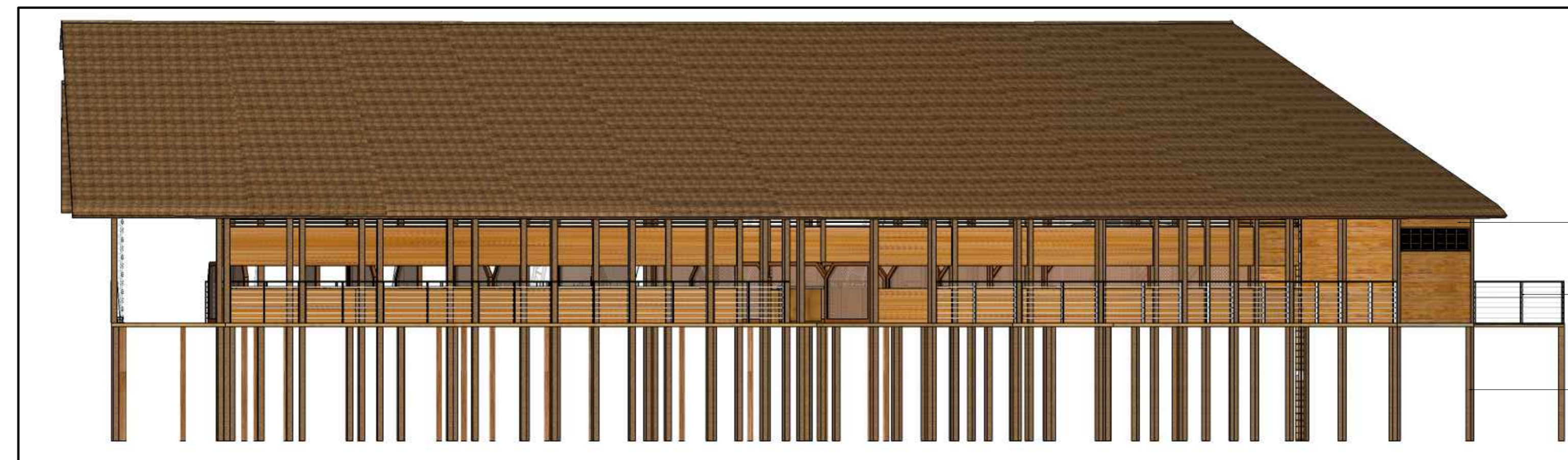

FACHADA LATERAL
esc. 1:100

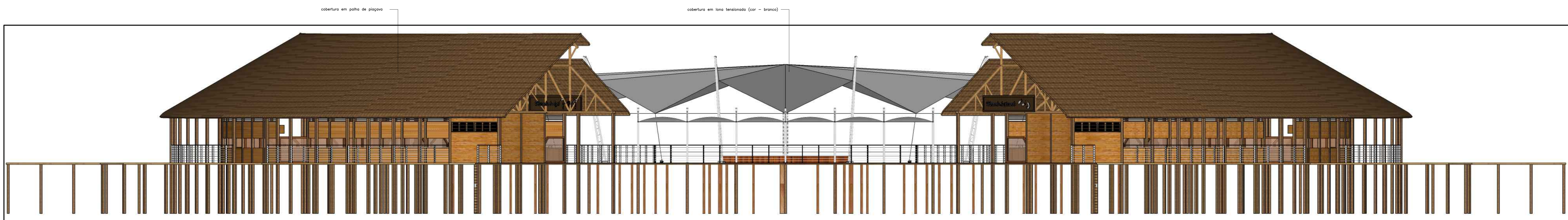

FACHADA FRONTAL
esc. 1:100

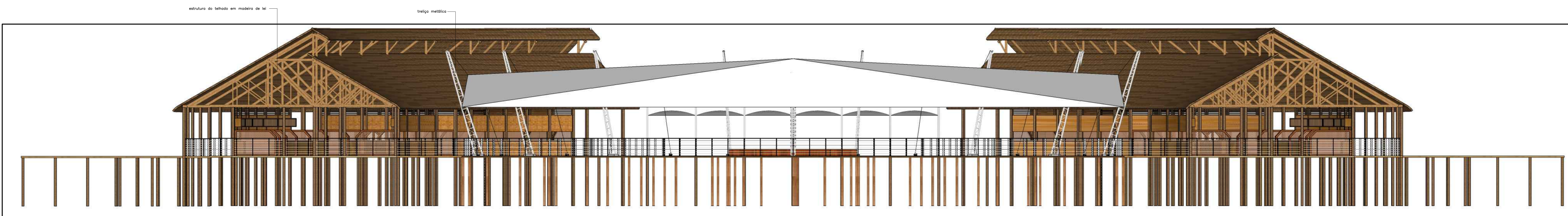

FACHADA POSTERIOR
esc. 1:100



PERSPECTIVA 1
sem escala



PERSPECTIVA 2
sem escala



PERSPECTIVA 3 - ATRACADOURO
sem escala

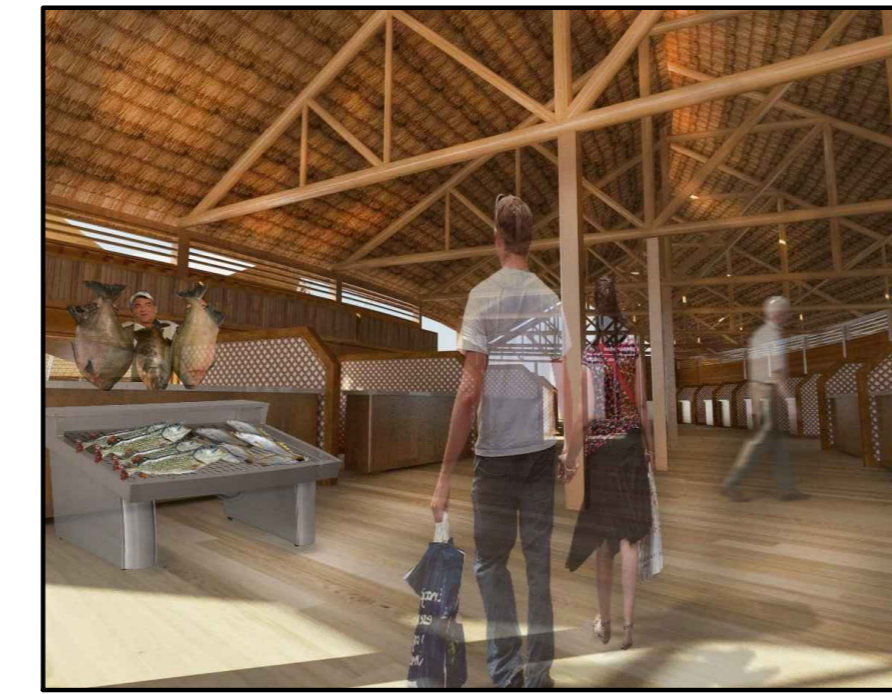

PERSPECTIVA 4 - INTERIOR
sem escala